

REVISION NOTES		
DESCRIPTION	ECN	PR/NOR
PRODUCTION RELEASE	PXECO169	N/A

LSDI5A5

LAB OPEN SCROLL 15HP TRIPLEX WITH 200 GALLON TANK

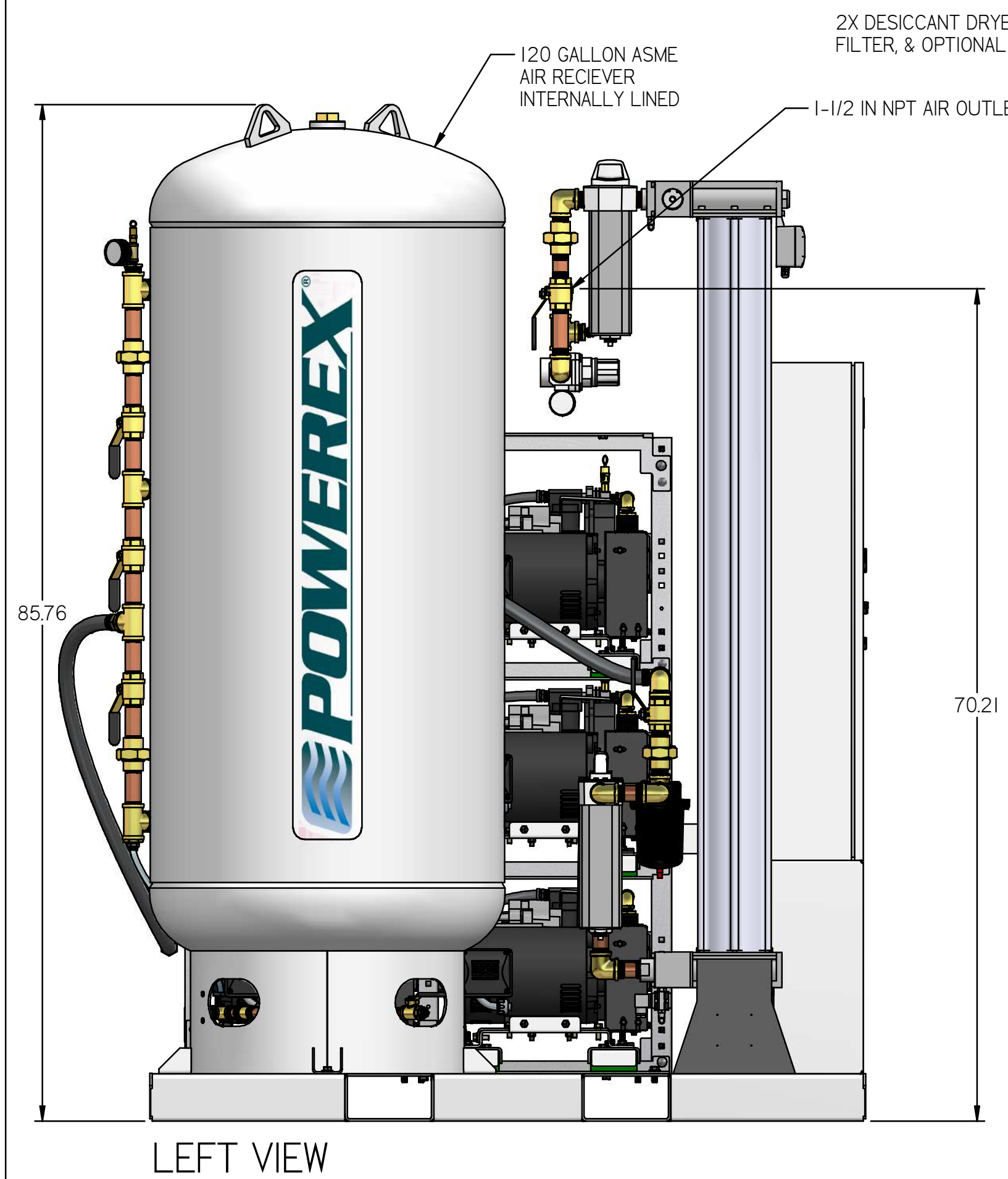
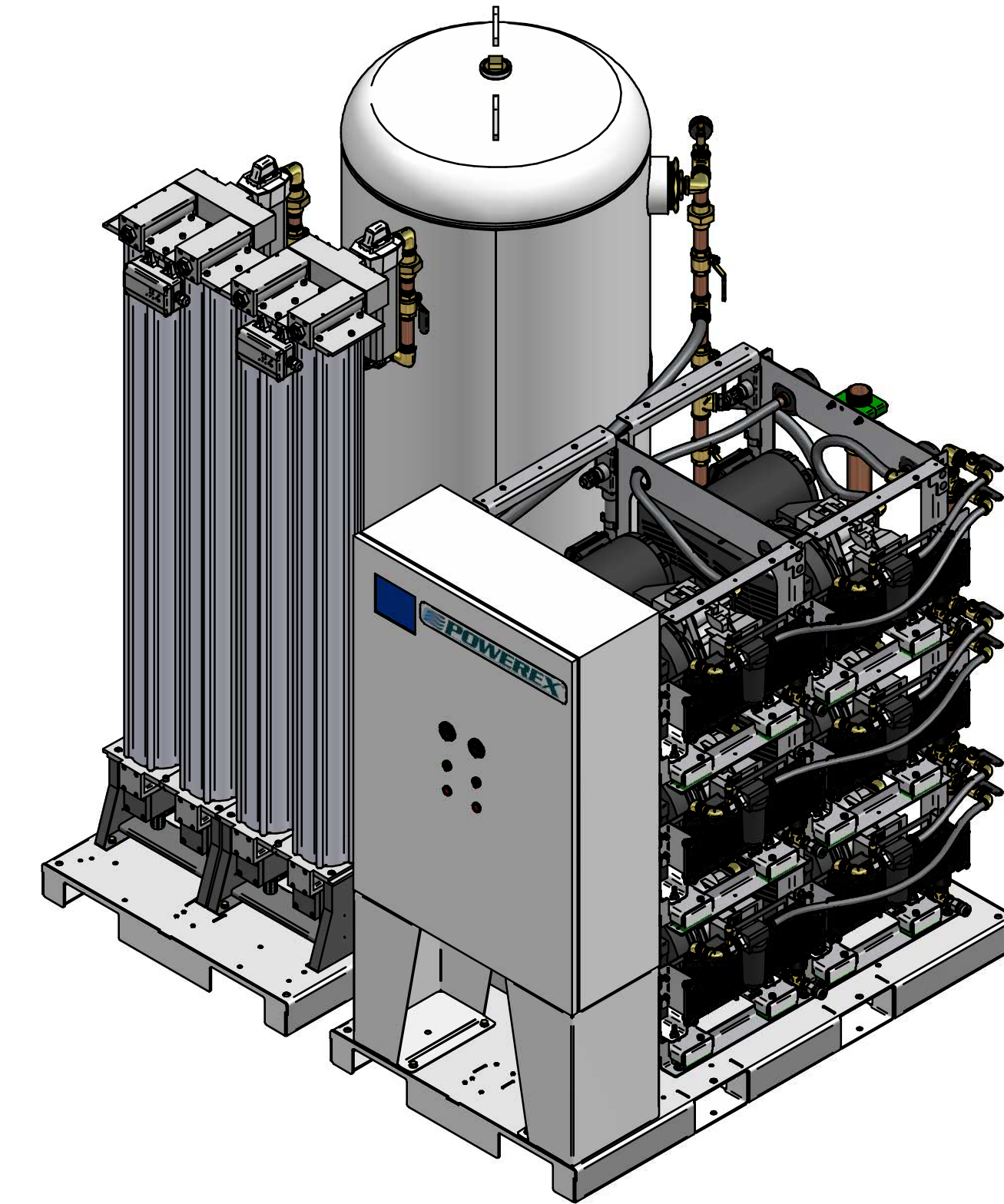
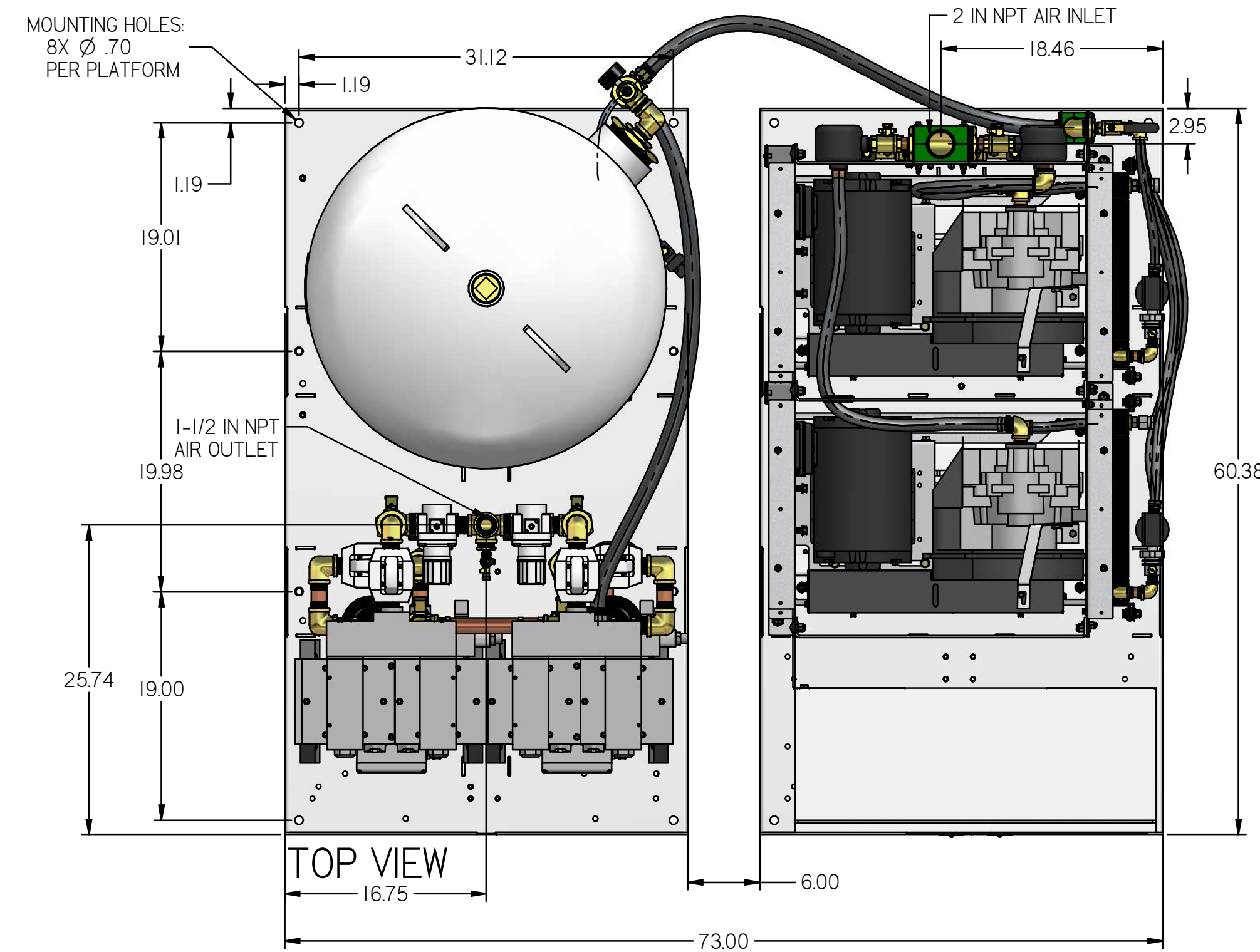

2X DESICCANT DRYER WITH PREFILTER, AFTER FILTER, & OPTIONAL CHARCOAL FILTER

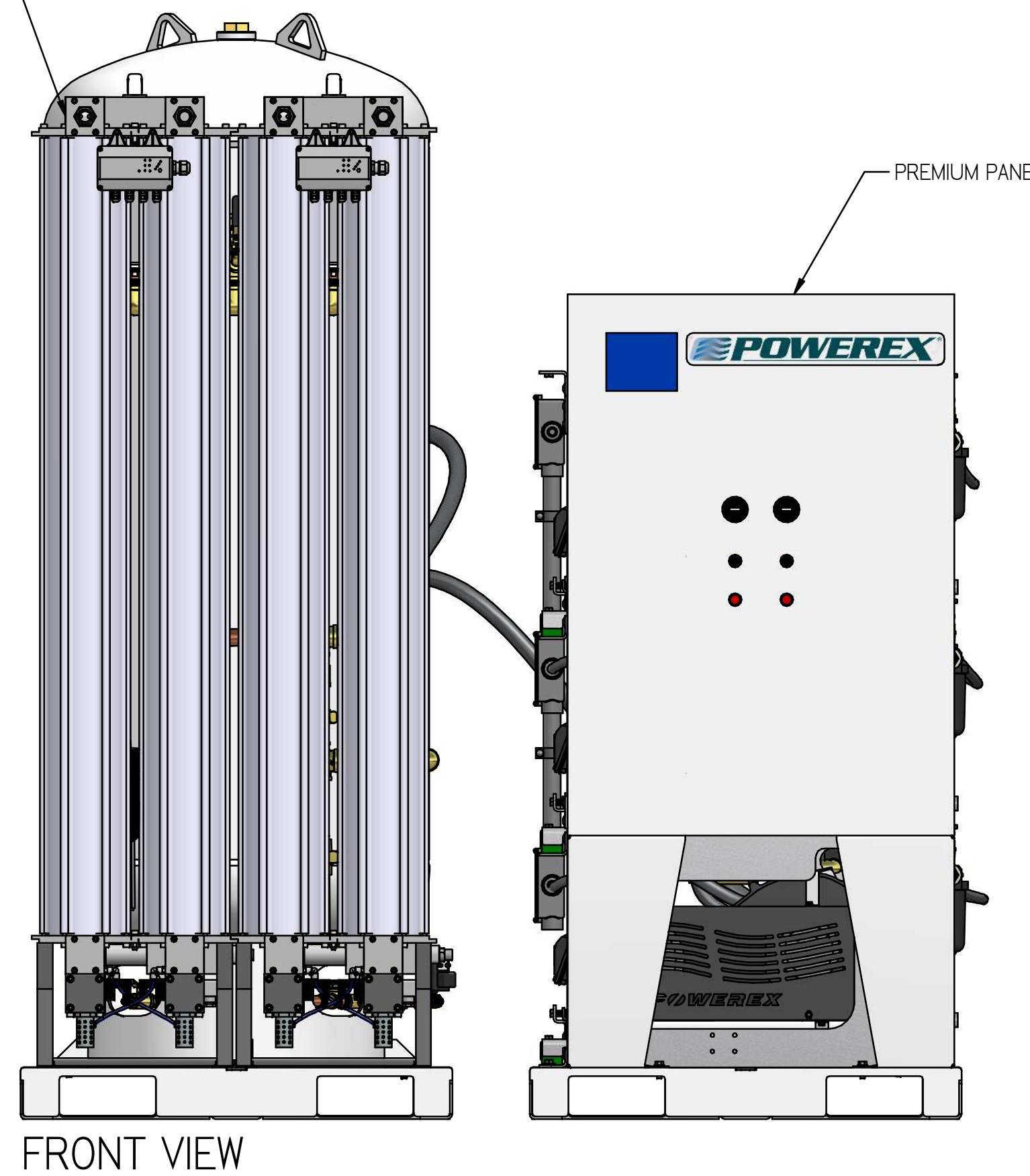

6X 5 HP OILESS SCROLL AIR END

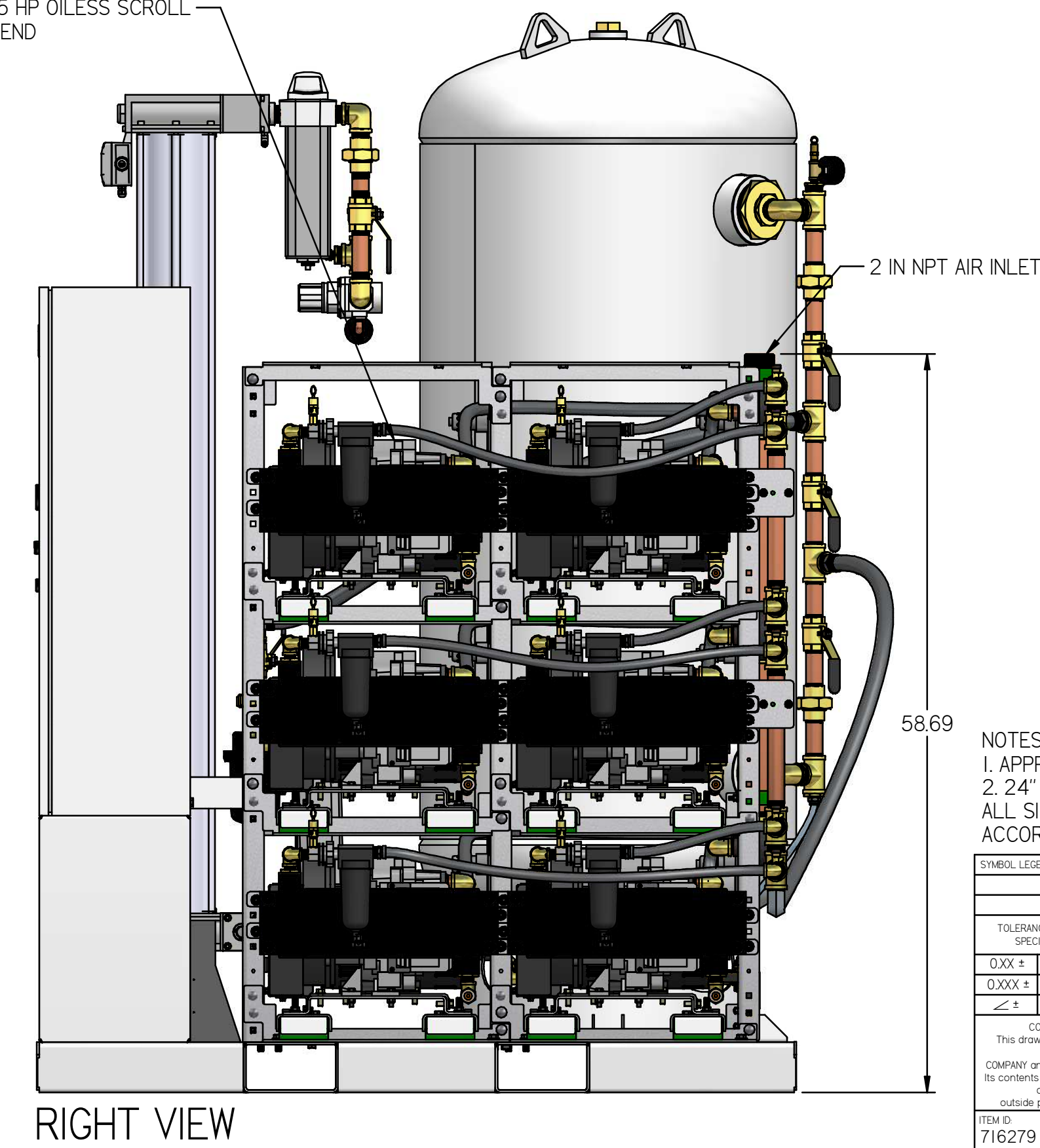

- NOTES:
 1. APPROX SYSTEM WEIGHT: 3282 LB
 2. 24" MINIMUM MAINTENANCE CLEARANCE RECOMMENDED ALL SIDES. CLEARANCE FOR CONTROL PANEL SHALL BE IN ACCORDANCE WITH OSHA/NEC REQUIREMENTS

SYMBOL LEGEND		DRAWINGS TO CONFORM TO CURRENT REVISION OF THE FOLLOWING ANSI STANDARDS:	
TOLERANCES NOT SPECIFIED	SOLID EDGE DRAWING	Y14.3 MULTI AND SECTIONAL VIEW DWGS	Y14.5 DIMENSIONING AND TOLERANCING
0.XXX ± .01	DRAWING	SHEET 1 OF 4	SCALE 1:10
0.XXX ± .005			
± .5	INCH	APPROVALS ON FILE IN PLM	
<small>CONFIDENTIAL DISCLOSURE</small> This drawing is the property of POWEREX of the SCOTT FETTER COMPANY and is subject to return on demand. Its contents are confidential and must not be copied or submitted to outside parties for use or examination.		AUTHOR	ORIGINATION DATE
TITLE: 716279		ASoulek	10/31/2018
MATERIAL: SEE PART DRAWINGS			
DESCRIPTION: LAB OPEN SCROLL 15HP TRIPLEX WITH 200 GALLON TANK		DRAWING NUMBER	REVISION
		LSDI5A5	B
			D

LSDI5A5

LAB OPEN SCROLL 15HP
TRIPLEX WITH 200 GALLON
TANK

FLOW DIAGRAM

REVISION NOTES		
DESCRIPTION	ECN	PR/NOR
PRODUCTION RELEASE	PXECO169	N/A

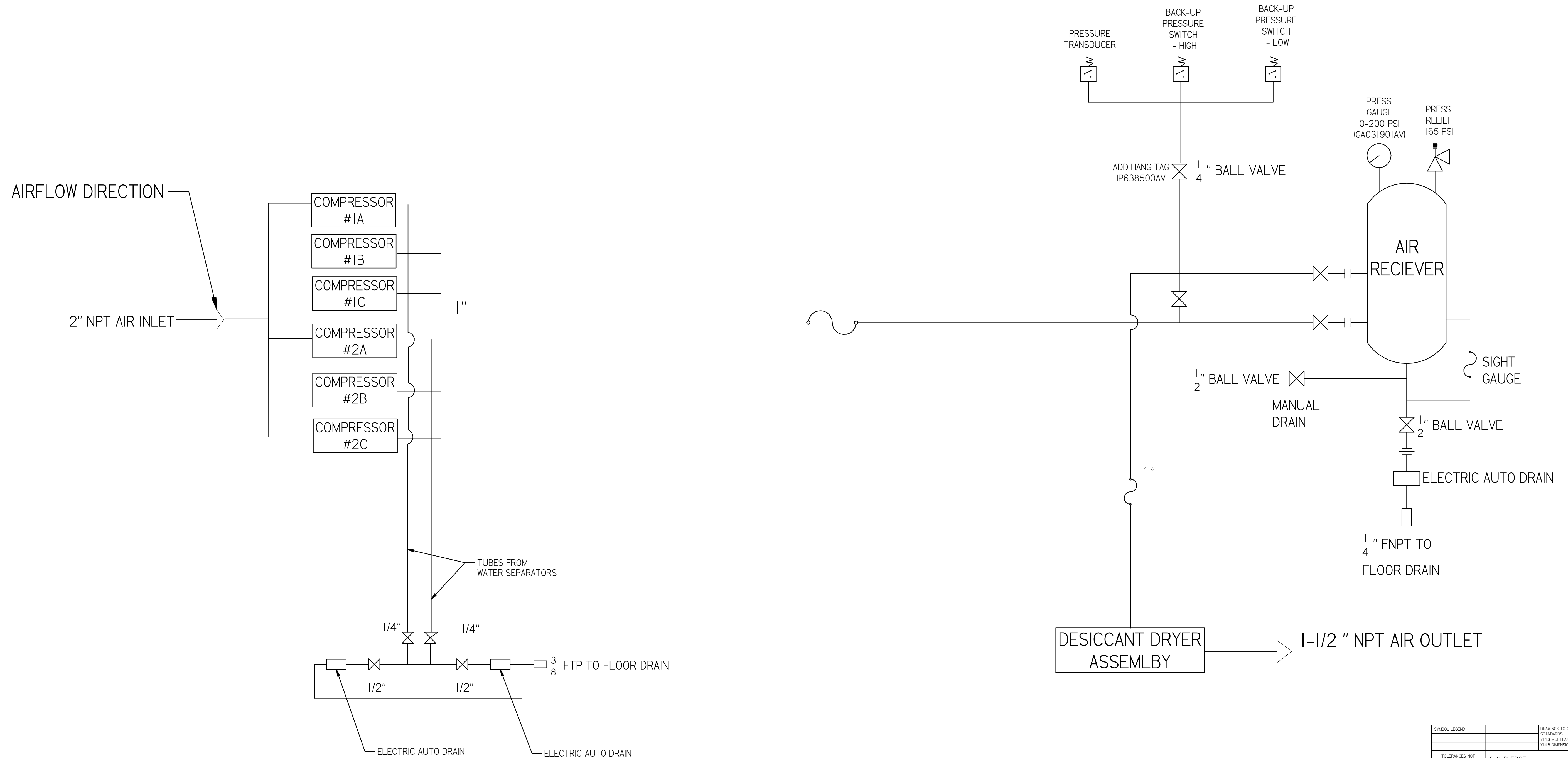





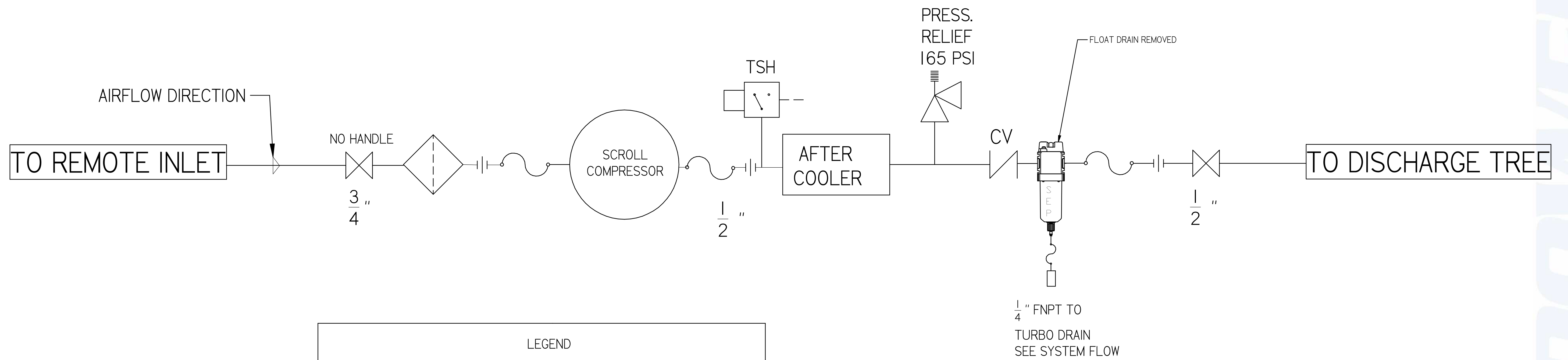

SYMBOL LEGEND		DRAWINGS TO CONFORM TO CURRENT REVISION OF THE FOLLOWING ANSI STANDARDS:			
		Y14.3 MULTI AND SECTIONAL VIEW DWGS			
		Y14.5 DIMENSIONING AND TOLERANCING			
TOLERANCES NOT SPECIFIED	SOLID EDGE DRAWING	DO NOT SCALE DRAWING FOR DIMENSIONS			
0.000 ± .01					
0.000 ± .005					
∠ ± .5	INCH	SHEET 2 OF 4	SCALE	I:1	
<small>CONFIDENTIAL DISCLOSURE</small> This drawing is the property of POWEREX or the SCOTT FETTER COMPANY and is subject to return on demand. Its contents are confidential and must not be copied or submitted to outside parties for use or examination.		AUTHOR	ORIGINATION DATE	APPROVALS ON FILE IN PLM	
		ASoulek	10/31/2018		
ITEM #: 716279					
MATERIAL: SEE PART DRAWINGS		<small>ISO PRODUCTION DRAWING, HARRISON OH 45030 888-716-7279</small>			
DESCRIPTION: LAB OPEN SCROLL 15HP TRIPLEX WITH 200 GALLON TANK		DRAWING NUMBER	REVISION	SIZE	
		LSDI5A5	B	D	

REVISION NOTES		
DESCRIPTION	ECN	PR/NOR
PRODUCTION RELEASE	PXECO169	N/A

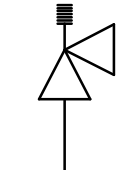
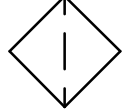
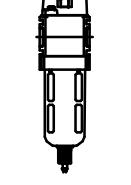
LSDI5A5

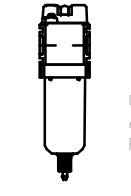
LAB OPEN SCROLL 15HP
TRIPLEX WITH 200 GALLON
TANK
LAB COMPRESSOR
FLOW DIAGRAM

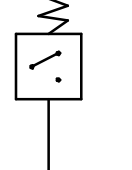
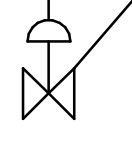
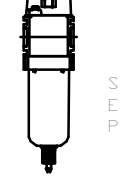

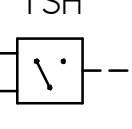
LEGEND	
	RELIEF VALVE
	INTAKE FILTER
	AIR FILTER
	3 WAY VALVE
	CARBON FILTER
	BALL VALVE
	PRESSURE SWITCH
	REGULATOR
	SEPARATOR
	CHECK VALVE
	FLEX LINE
	TSH HIGH TEMP SWITCH

SYMBOL LEGEND		DRAWINGS TO CONFORM TO CURRENT REVISION OF THE FOLLOWING ANSI STANDARDS:	
		Y14.3 MULTI AND SECTIONAL VIEW DWGS Y14.5 DIMENSIONING AND TOLERANCING	
TOLERANCES NOT SPECIFIED	SOLID EDGE DRAWING	DO NOT SCALE DRAWING FOR DIMENSIONS	
0.000 ± .01		SHEET 3 OF 4	SCALE 1:1
0.000 ± .005	INCH		
CONFIDENTIAL DISCLOSURE This drawing is the property of POWEREX of the SCOTT FETTER COMPANY and is subject to return on demand. Its contents are confidential and must not be copied or submitted to outside parties for use or examination.		AUTHOR	APPROVALS ON FILE IN PLM
		ASoulek	10/31/2018
ITEM NO: 716279			
MATERIAL: SEE PART DRAWINGS		150 PRODUCTION DRIVE, HARRISON OH 45030 888-716-7279	
DESCRIPTION: LAB OPEN SCROLL 15HP TRIPLEX WITH 200 GALLON TANK		DRAWING NUMBER: LSDI5A5	REVISION: B D

REVISION NOTES		
DESCRIPTION	ECN	PR/NOR
PRODUCTION RELEASE	PXECO169	N/A

LSDI5A5

LAB OPEN SCROLL 15HP
TRIPLEX WITH 200 GALLON
TANK
LAB DRYER
FLOW DIAGRAM

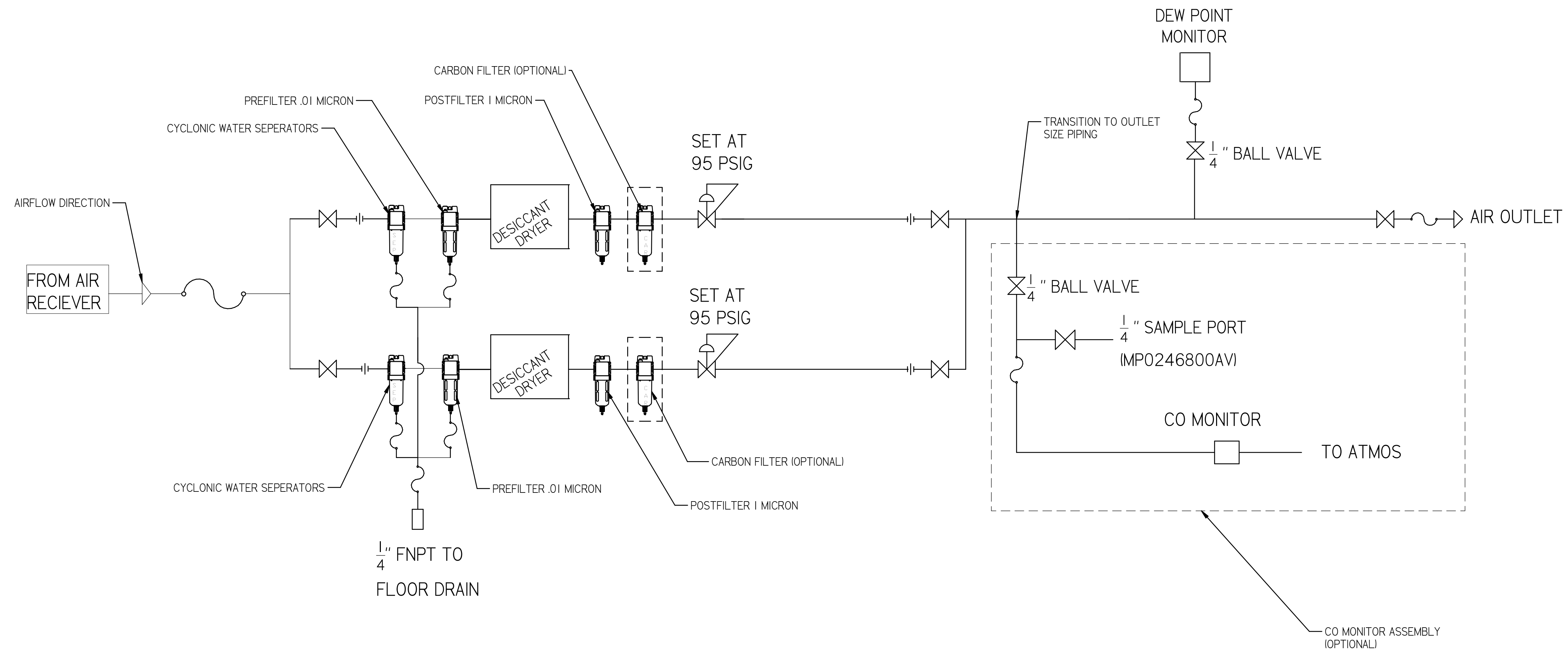

PUMP COUNT	DRYER PLUMBING SIZE	OUTLET PIPE SIZE
2	1/2"	1/2"
3	1/2"	1"
4	1"	1-1/4"
6	1"	1-1/2"
8	1"	1-1/2"
9	1"	1-1/2"
12	1-1/2"	2"
15	1-1/2"	2"
18	1-1/2"	2"

SYMBOL LEGEND		DRAWINGS TO CONFORM TO CURRENT REVISION OF THE FOLLOWING ANSI STANDARDS: Y14.3 MULTI AND SECTIONAL VIEW DWGS Y14.5 DIMENSIONING AND TOLERANCING	
TOLERANCES NOT SPECIFIED	SOLID EDGE DRAWING	DO NOT SCALE DRAWING FOR DIMENSIONS	
0.XXX ± .01	INCH	SHEET 4 OF 4	SCALE 1:1
0.XXX ± .005			
∠ ± .5	CONFIDENTIAL DISCLOSURE This drawing is the property of POWEREX or the SCOTT FETTER COMPANY and is subject to return on demand. Its contents are confidential and must not be copied or submitted to outside parties for use or examination.	AUTHOR	APPROVALS ON FILE IN PLM
716279	ASoulek	ORIGINATION DATE	10/31/2018
SEE PART DRAWINGS			<small>150 PRODUCTION DRIVE, HARRISON OH 45030 888-716-7279</small>
LAB OPEN SCROLL 15HP TRIPLEX WITH 200 GALLON TANK	DRAWING NUMBER LSDI5A5	REVISION B	SIZE D

