

LST15A5

LAB OPEN SCROLL 15HP
TRIPLEX WITH 200 GALLON
TANK

REVISION NOTES		
DESCRIPTION	ECN	PR/NOR
PRODUCTION RELEASE	PXEC0169	N/A

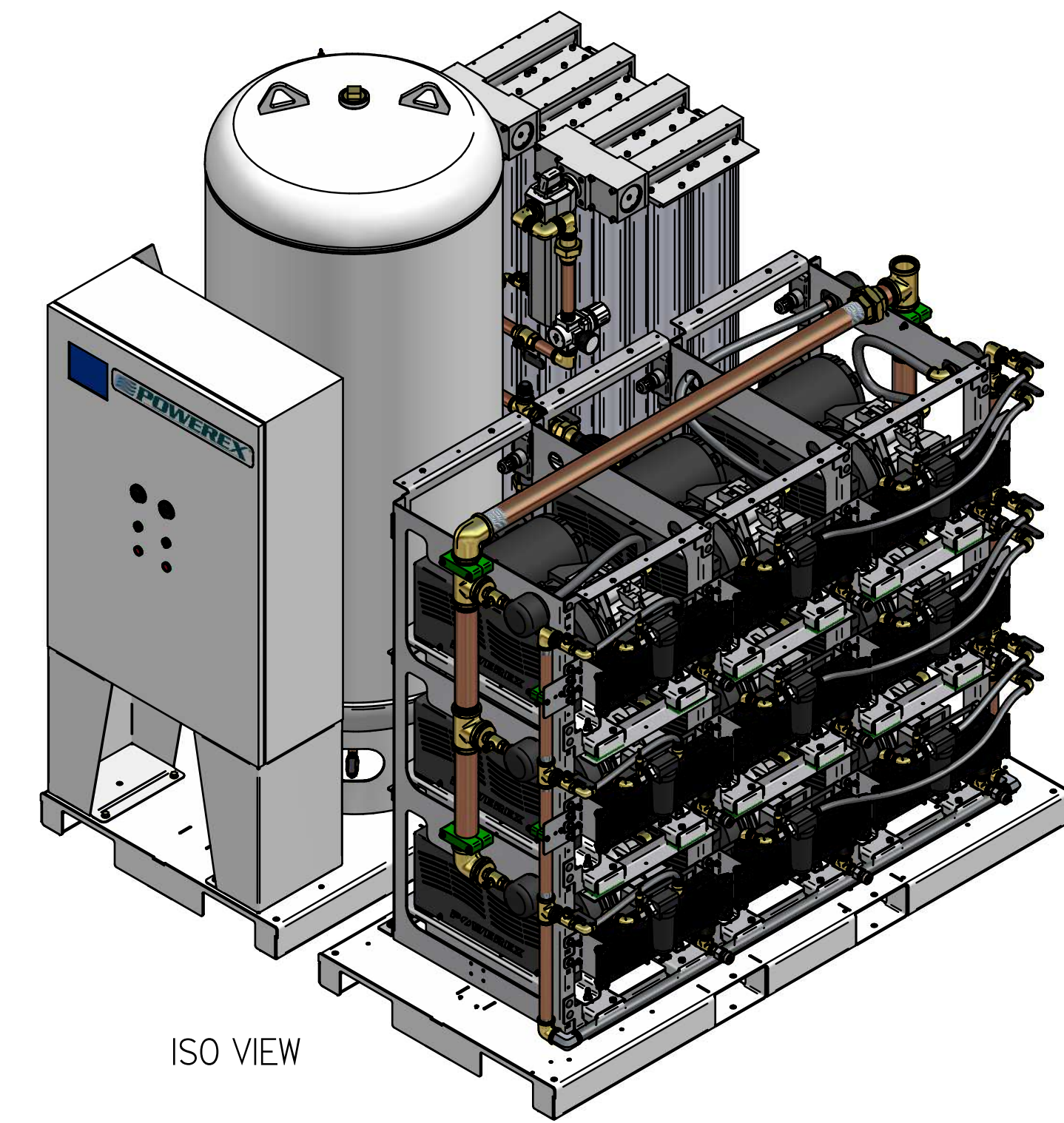
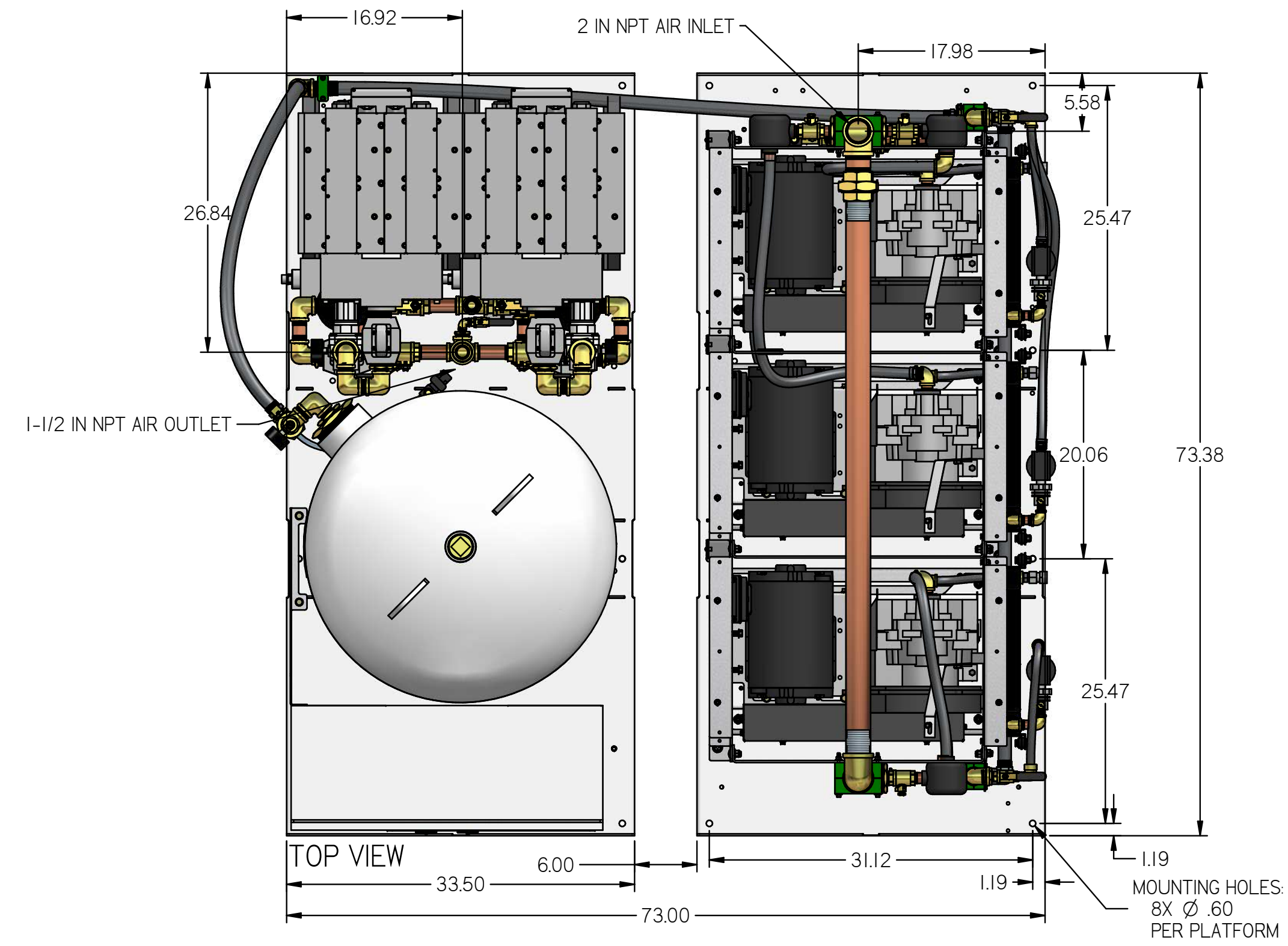

ISO VIEW

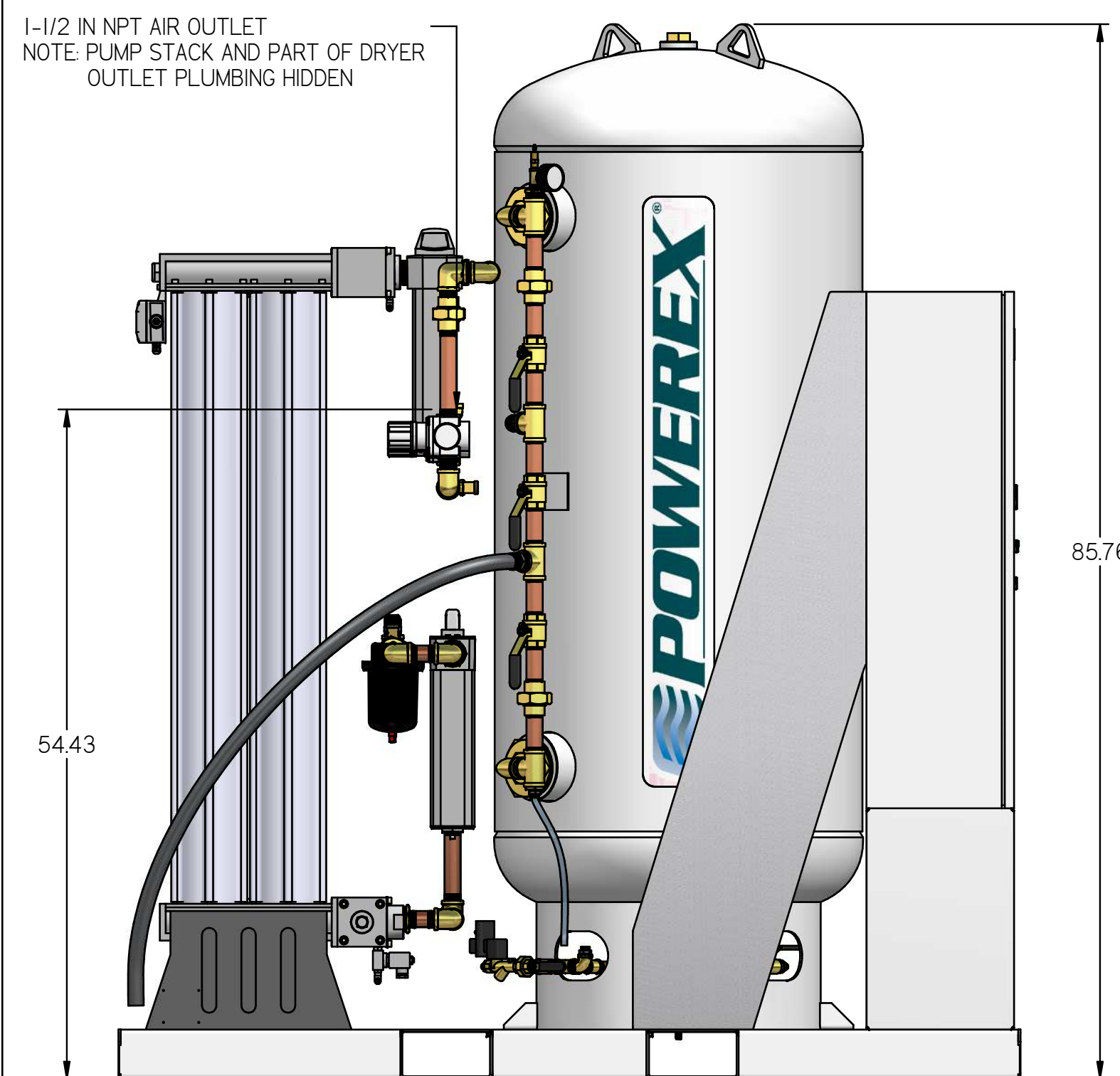

LEFT VIEW

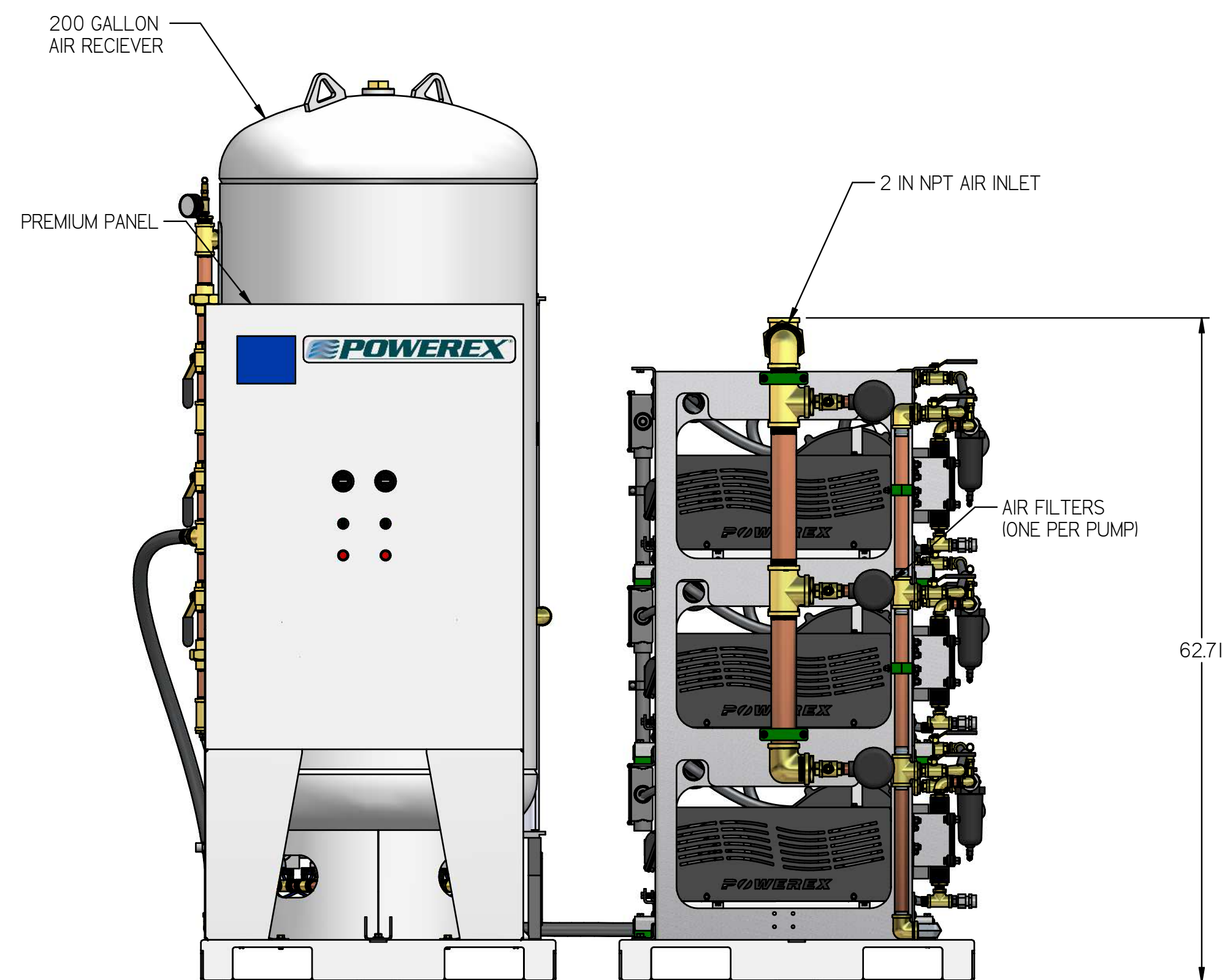

FRONT VIEW

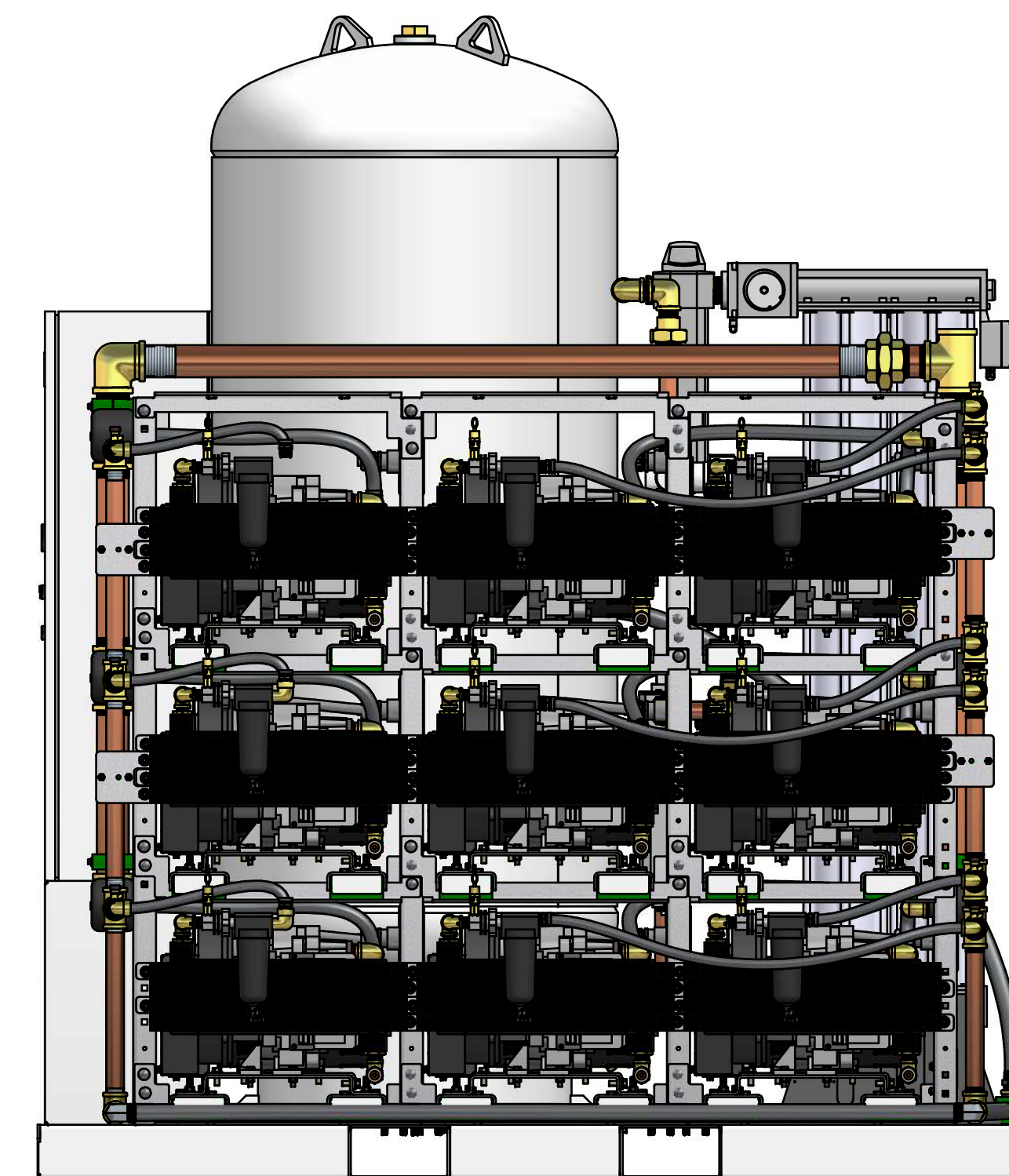

RIGHT VIEW

- NOTES:
1. APPROX SYSTEM WEIGHT: 4699 LB
2. 24" MINIMUM MAINTENANCE CLEARANCE RECOMMENDED ALL SIDES. CLEARANCE FOR CONTROL PANEL SHALL BE IN ACCORDANCE WITH OSHA/NEC REQUIREMENTS

SYMBOL LEGEND		DRAWINGS TO CONFORM TO CURRENT REVISION OF THE FOLLOWING ANSI STANDARDS:	
TOLERANCES NOT SPECIFIED	SOLID EDGE DRAWING	1:4:3 MULTI AND SECTIONAL VIEW DIMS	1:4:3 DIMENSIONING AND TOLERANCING
0.XXX ± .01			
0.XXX ± .005			
± .5	INCH	SHEET 1 OF 4	SCALE 1:1:1
<small>CONFIDENTIAL DISCLOSURE</small> This drawing is the property of POWEREX of the SCOTT FETTER COMPANY and is subject to return on demand. Its contents are confidential and must not be copied or submitted to outside parties for use or examination.		AUTHOR	APPROVALS ON FILE IN PLM
TITLE: 716072 MATERIAL: SEE PART NOTES		ORIGINATION DATE: 11/5/2018	
DESCRIPTION: LAB OPEN SCROLL 15HP TRIPLEX WITH 200 GALLON TANK			
		DRAWING NUMBER: LST15A5	REVISION: B
			SIZE: D

LST15A5

LAB OPEN SCROLL 15HP
TRIPLEX WITH 200 GALLON
TANK

SYSTEM FLOW DIAGRAM

REVISION NOTES		
DESCRIPTION	ECN	PR/NOR
PRODUCTION RELEASE	PXECO169	N/A

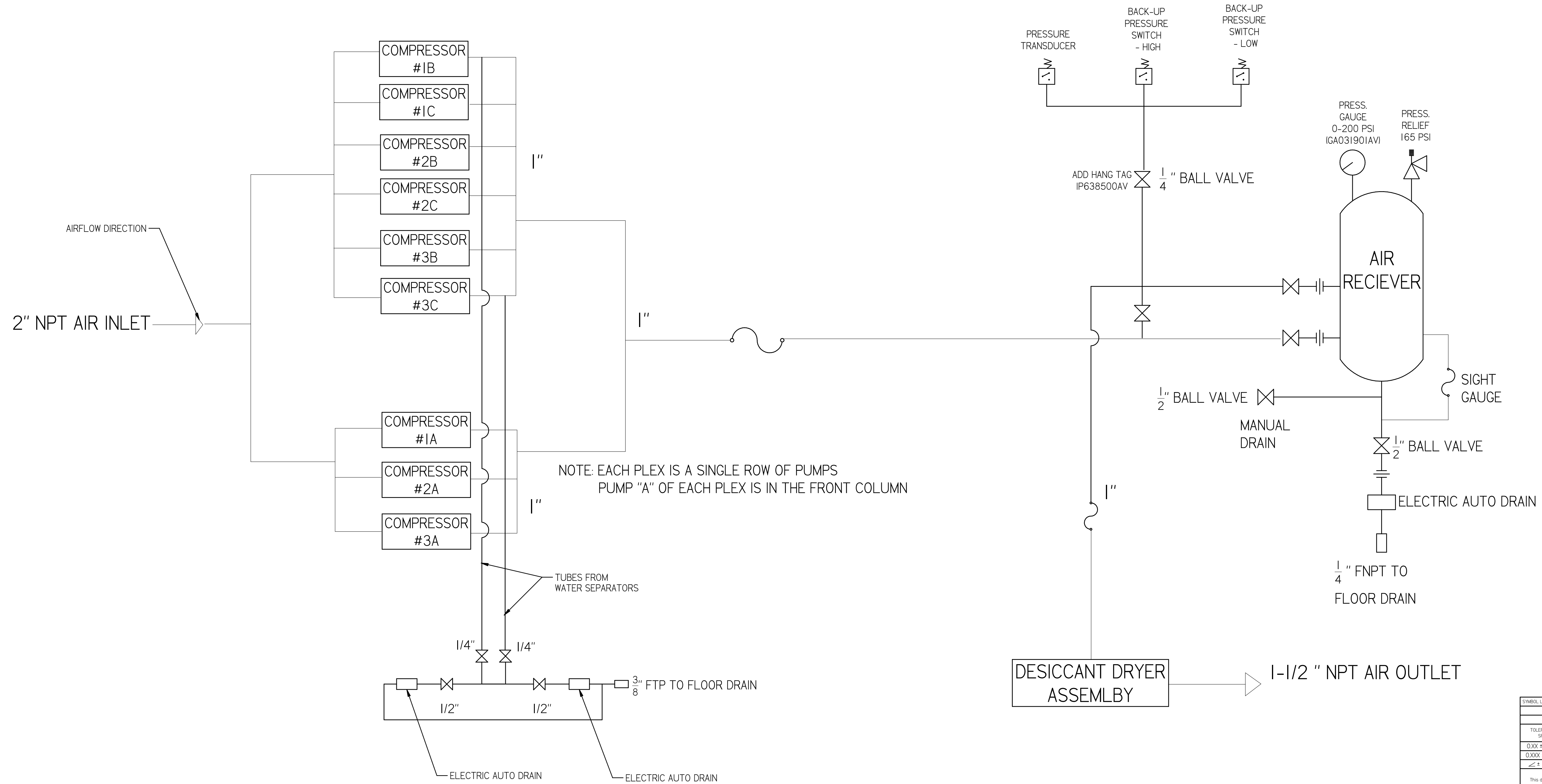

SYMBOL LEGEND	DRAWINGS TO CONFORM TO CURRENT REVISION OF THE FOLLOWING ANSI STANDARDS: Y14.3 MULTI AND SECTIONAL VIEW DIMS Y14.5 DIMENSIONING AND TOLERANCING			
TOLERANCES NOT SPECIFIED	SOLID EDGE DRAWING	DO NOT SCALE DRAWING FOR DIMENSIONS		
0.XXX ± .01		INCH	SHEET 2 OF 4	SCALE 1:1
0.XXX ± .005	<small>CONFIDENTIAL DISCLOSURE</small> This drawing is the property of POWEREX of the SCOTT FETTER COMPANY and is subject to return on demand. Its contents are confidential and must not be copied or submitted to outside parties for use or examination.		AUTHOR	ORIGINATION DATE
± .5		ASoulek	11/5/2018	
ITEM NO: 716072			<small>150 PRODUCTION DRIVE, HARRISON OH 45030 888-768-7079</small>	
MATERIAL: SEE PART NOTES			DRAWING NUMBER LST15A5	REVISION B
DESCRIPTION: LAB OPEN SCROLL 15HP TRIPLEX WITH 200 GALLON TANK				





REVISION NOTES		
DESCRIPTION	ECN	PR/NOR
PRODUCTION RELEASE	PXECO169	N/A

LST15A5

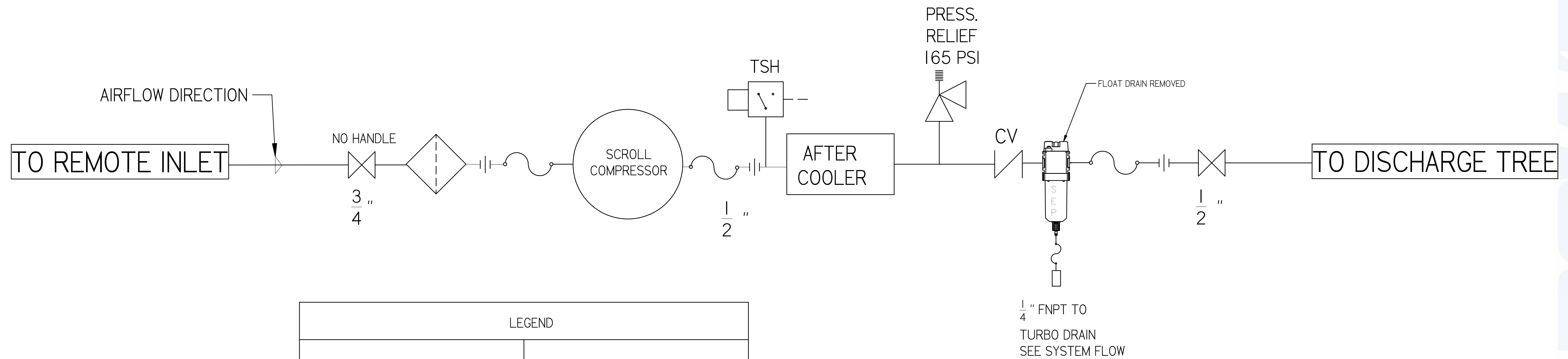
LAB OPEN SCROLL 15HP
TRIPLEX WITH 200 GALLON
TANK

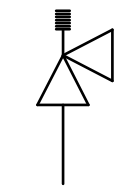
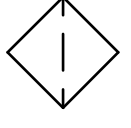
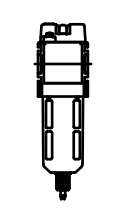
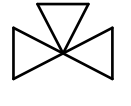
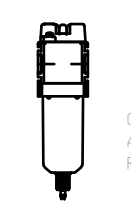
LAB COMPRESSOR
FLOW DIAGRAM

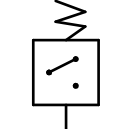
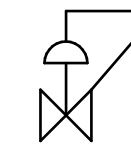
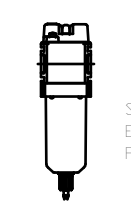

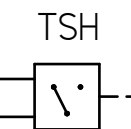
LEGEND	
	RELIEF VALVE
	INTAKE FILTER
	AIR FILTER
	3 WAY VALVE
	CARBON FILTER
	BALL VALVE
	PRESSURE SWITCH
	REGULATOR
	SEPARATOR
	CHECK VALVE
	FLEX LINE
	TSH HIGH TEMP SWITCH

SYMBOL LEGEND		DRAWINGS TO CONFORM TO CURRENT REVISION OF THE FOLLOWING ANSI STANDARDS:	
		Y14.3 MULTI AND SECTIONAL VIEW DWGS Y14.5 DIMENSIONING AND TOLERANCING	
TOLERANCES NOT SPECIFIED	SOLID EDGE DRAWING	DO NOT SCALE DRAWING FOR DIMENSIONS	
0.001 ± .001			
0.005 ± .005	INCH	SHEET 3 OF 4	SCALE 1:1
<small>CONFIDENTIAL DISCLOSURE</small> This drawing is the property of POWEREX of the SCOTT FETTER COMPANY and is subject to return on demand. Its contents are confidential and must not be copied or submitted to outside parties for use or examination.		AUTHOR	APPROVALS ON FILE IN PLM
TITLE: 716072		ASoulek	11/5/2018
MATERIAL: SEE PART NOTES			
DESCRIPTION: LAB OPEN SCROLL 15HP TRIPLEX WITH 200 GALLON TANK		DRAWING NUMBER LST15A5	REVISION B D

REVISION NOTES		
DESCRIPTION	ECN	PR/NOR
PRODUCTION RELEASE	PXECO169	N/A

LST15A5

LAB OPEN SCROLL 15HP TRIPLEX WITH 200 GALLON TANK

LAB DRYER FLOW DIAGRAM

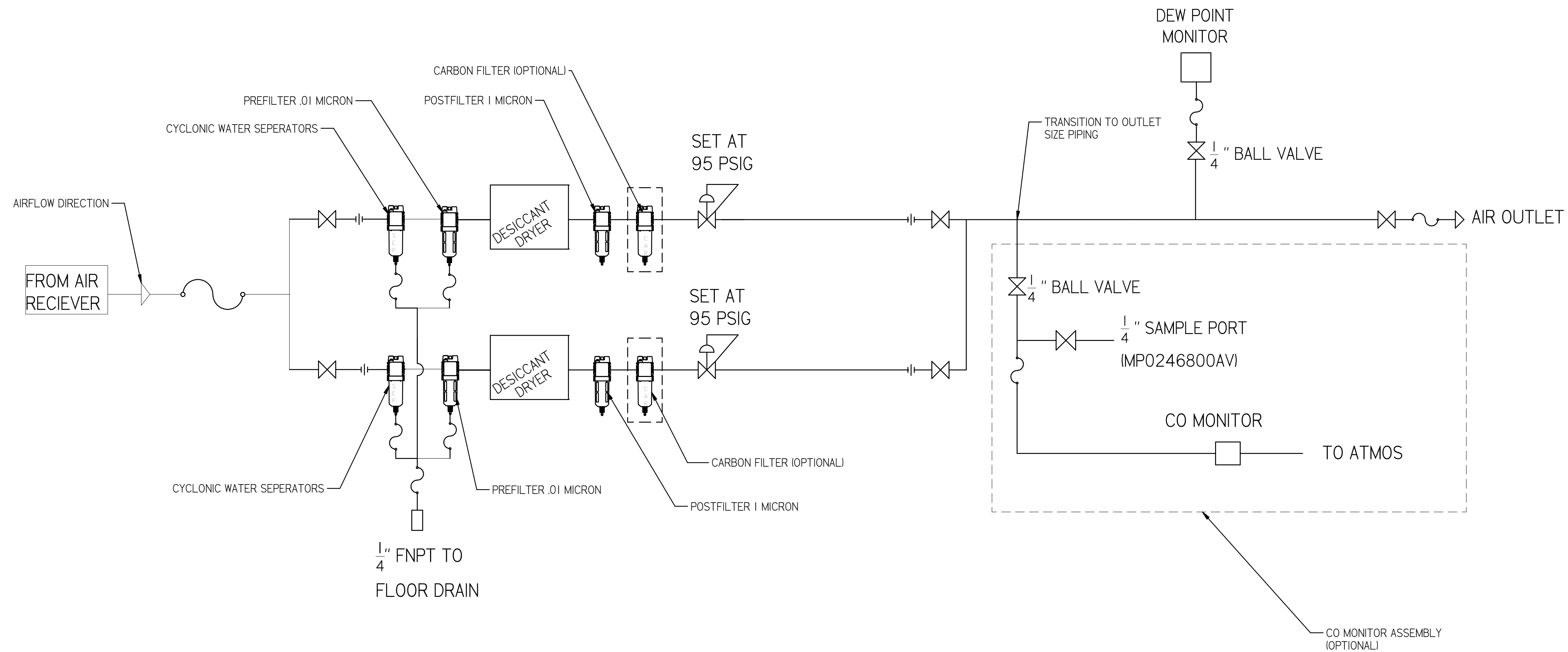

PIPE SIZE CHART		
PUMP COUNT	DRYER PLUMBING SIZE	OUTLET PIPE SIZE
2	1/2"	1/2"
3	1/2"	1"
4	1"	1-1/4"
6	1"	1-1/2"
8	1"	1-1/2"
9	1"	1-1/2"
12	1-1/2"	2"
15	1-1/2"	2"
18	1-1/2"	2"

SYMBOL LEGEND		DRAWINGS TO CONFORM TO CURRENT REVISION OF THE FOLLOWING ANSI STANDARDS: Y14.3 MULTI AND SECTIONAL VIEW DIMS Y14.5 DIMENSIONING AND TOLERANCING	
TOLERANCES NOT SPECIFIED	SOLID EDGE DRAWING	DO NOT SCALE DRAWING FOR DIMENSIONS	
0.XXX ± .01	INCH	SHEET 4 OF 4	SCALE 1:1
0.XXX ± .005			
± .5			
<small>CONFIDENTIAL DISCLOSURE</small> This drawing is the property of POWERLEX of the SCOTT FETTER COMPANY and is subject to return on demand. Its contents are confidential and must not be copied or submitted to outside parties for use or examination.		AUTHOR	ORIGINATION DATE
<small>FROM:</small> 716072 <small>MATERIAL:</small> SEE PART NOTES		ASoulek	11/5/2018
<small>DESCRIPTION:</small> LAB OPEN SCROLL 15HP TRIPLEX WITH 200 GALLON TANK		<small>DRAWING NUMBER:</small> LST15A5	<small>REVISION:</small> B <small>SIZE:</small> D

